 **Nyloc Nut:** When installing in an area that does not allow access to the backside of the mounting surface.

 **Well Nut:** when installing when there is no access to the backside of the mounting surface.

Tools



#2

5/32"

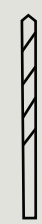

#8-32 PH machine screw



x6

#8 flat washer



x6

#8-32 nyloc nut



x6

5/16"

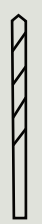

#8-32 PH machine screw



x6

#8-32 well nut



x6

